

MAXON®

Slidelift

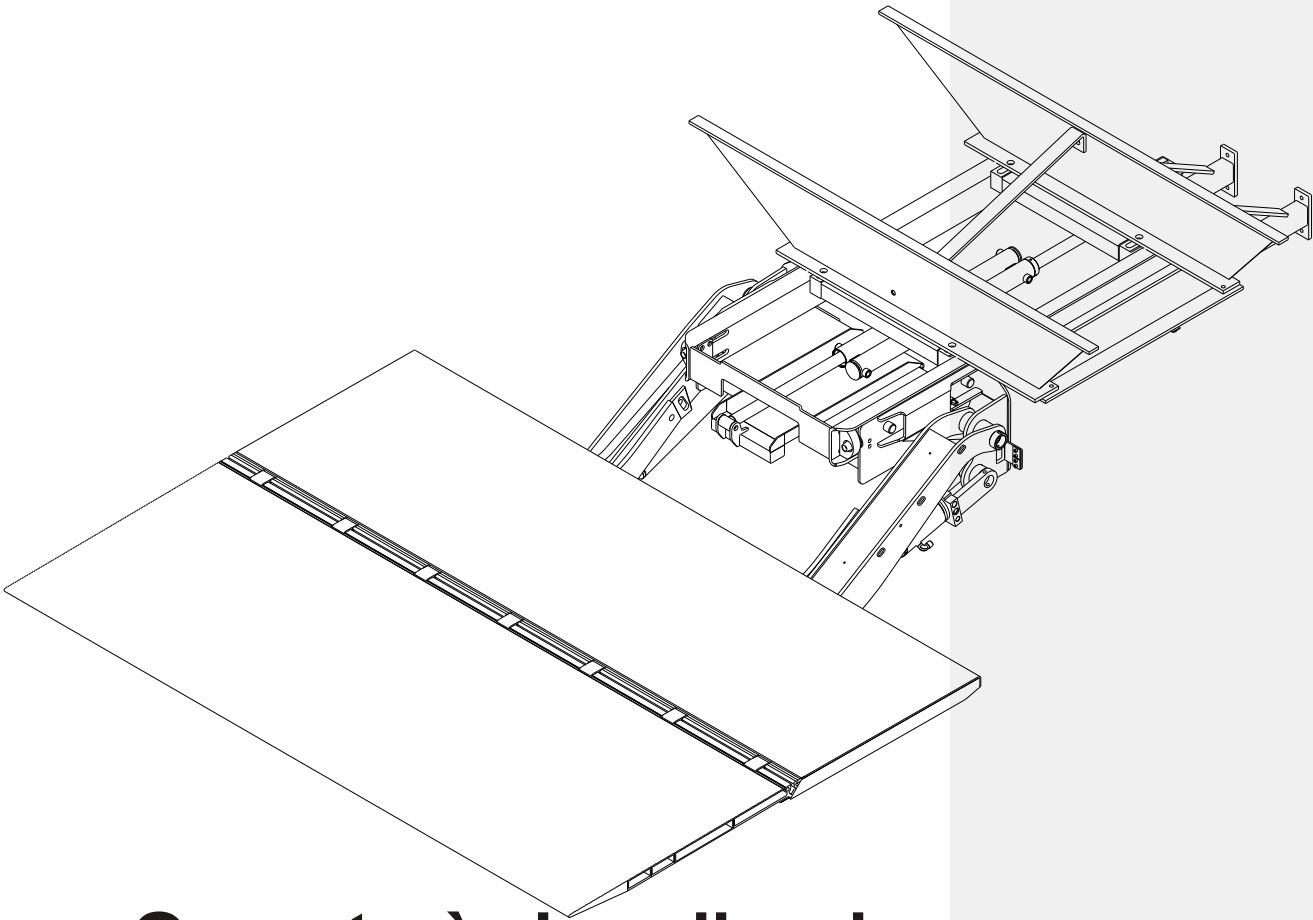

Operator`s handbook

GPSS 33 X1

MAXON®
Lift CORP.

11921 Slauson Avenue.
Santa Fe Springs, CA 90670
(800) 227 - 4116

X1
TECHNOLOGY

Version : 20.01.2004

General information

You have decided to purchase a top Slidelift. The Maxon Slidelift is very easy to use and to maintain. It is equipped with maintenance and grease-free bearings, and does not require greasing throughout its entire lifetime. The Maxon Slidelift is only to be used for lifting and lowering of loads, which have to be placed on the platform in accordance with the loading diagram.

The Slidelift must only be operated, maintained and repaired by persons who have been technically trained and who have especially been informed about the hazards that may occur during operation. Otherwise, manufacturer's liability for resulting damages is void.

These operating instructions are valid for following lifts:

Model	GPSS 33 X1
Capacity	3,300 lbs

Daily verifications :

1. Function and completeness of all operating and security equipment
2. Legibility of all operating and information labels (replace if necessary)
3. Damages and completeness on bolts, bolt retainers, cracked or broken bolts and nuts
4. Damages and tightness of hoses, fittings and valves on hydraulic cylinders. Check all hoses for leaks and tightness
5. Verify deformation of under ride device and energy absorber
6. Damages and function of platform warning lights
7. The function of the battery main switch (option) is to be checked

Recommended checks every month:

1. Check hydraulic fittings for tightness and tightening torque.
2. Check oil level.
If necessary correct with recommended oil.
3. Check wires and cables for damages.
Replace missing cable fasteners.
Correct if there are cutting and shearing risks.
4. Check hydraulic hoses for damages.
Replace missing fasteners.
Correct if there are cutting and shearing risks.
5. Check that all decals are in place and full readable.
Replace missing or damaged decals.
6. Check rubber seals at bearings.
Replace missing or damaged seals.
7. Check that all bearing pins are secured and without damage.
Replace if necessary.

Recommended checks and maintenances every year:

1. Oil change.
Clean oil suction filter and air breather filter.
Fill up with recommended oil.
2. Hydraulic hoses.
Change every four years, or if damages appear.
3. Electric motors.
Check carbon brushes, and clean with compressed air.
4. Check battery voltage.
Measure acid density.
Clean cable connections at the battery.
5. Load test.
Function test with nominal load.
6. Check foot controls
If necessary renew the switch or the rubber.
7. Check mechanical components for cracks or deformation.

Any failure must be repaired immediately and any missing part is to be replaced at once!
The vehicle operator is responsible for repairs in due time of known damages
The operating instructions are to be carried in the vehicle at all times.

Annual verifications

The Slidelift is to be verified by an expert once a year after its first operation. The results of that verification must be written down in the control book.

Battery capacity

Lifting capacity	3,300 lbs
Battery - Size	Group 31 to Battery

When driving short distances, always choose higher battery capacity.
Reinforced alternators are always recommended

The operator is responsible for battery capacity and its loading condition

Switching on the "SlideLift"









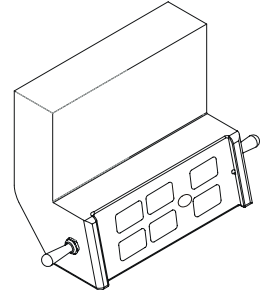

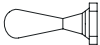

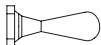









A master power switch is located in the pump box, and must be in the "On" position prior to operating lift. Green light will illuminate.

Description Operation of Controls

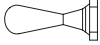
Control Box

Using the control box, both hands must be used to operate control box.

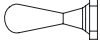

				
Function		Toggle Switch Left	Pushbutton	Toggle Switch Right
lift				
lower				
tilt down				
tilt up				
slide out				
slide in				

Foot Controls

The foot controls are connected so that they only work when pushed in a specific order.

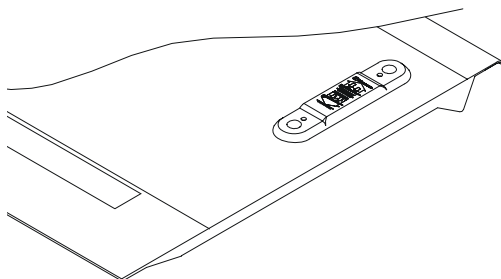

To lift and tilt up

- Step 1 - activate foot control button for lowering
- Step 2 - activate foot control button for lifting

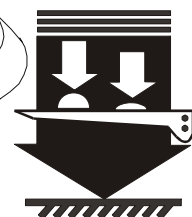
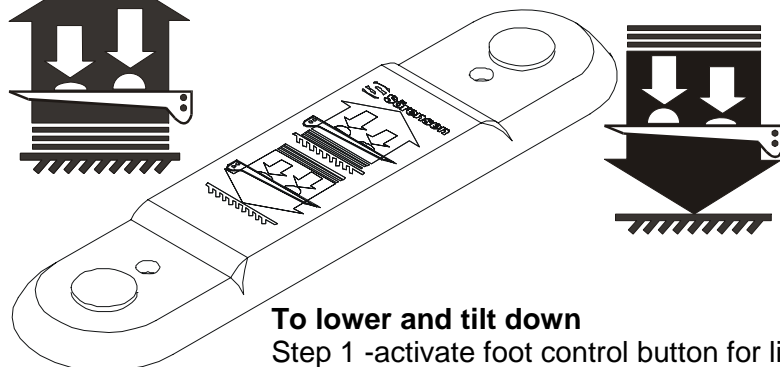

To lower and tilt down

- Step 1 - activate foot control button for lifting
- Step 2 - activate foot control button for lowering

Hand Controls

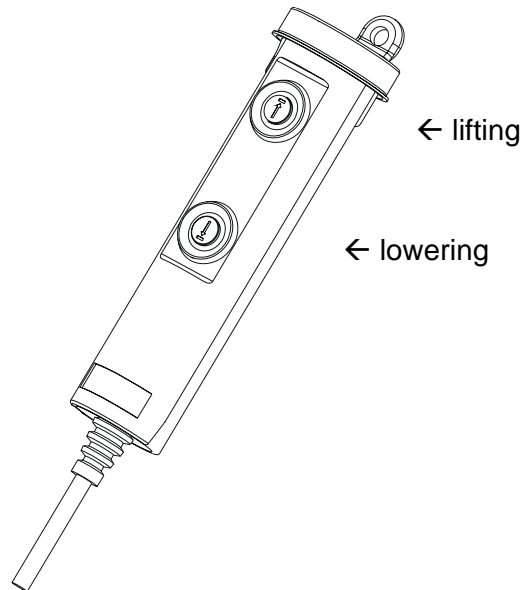

General information

Riding on the platform

As only one person at a time is allowed to ride on the platform, the operator must ensure to avoid any endangering of other persons (especially children) while operating the Slidelift.

Description of the security devices

Hose bursting valves

If a hose, a tube or a fitting should burst, the lift will lower in a controlled manner, without exceeding the maximum allowed speed, as long as one of the functions of the hand control box is activated. If the control is not operated any more, the lift stops immediately.

Pressure relief valve

The lift is secured against the lifting of loads which are heavier than its capacity, by an overload security valve, set at the factory. An adjustment of this valve is allowed only by an expert, equipped with a pressure gauge and an appropriate test load.

Electrical fuses

Defective fuses must be replaced by ones of same value, as stated on the wiring diagram.

Roll-off securities

The platform must be fitted with cart stops when using carts. The function of cart stops can be altered through dirt. The operator must keep them clean at all times.

Warning lights

Warning lights are flashing when switching the lift on. Security equipment should always be in perfect condition and kept clean.

Riding on the platform

When loading the platform, please leave enough space to ensure that the operator can ride and operate the platform safely. The handle (optional) must be within reach at all times during vertical platform travel.

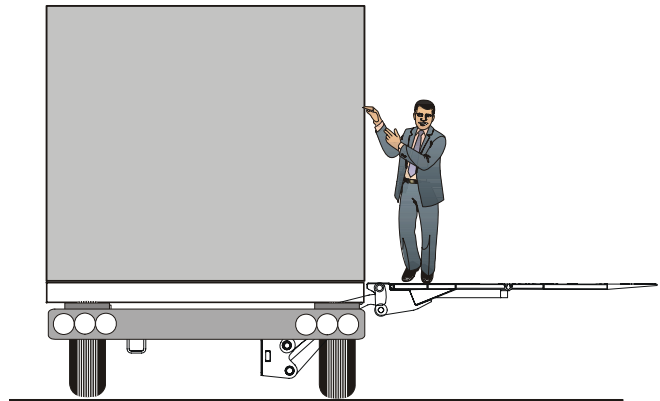

Securing the loads

Rolling and shifting loads must be secured on the platform. On request, Maxon Slidelifts can be equipped with cart stops, securing rolling loads with the maximum efficiency (wheels with maximum diameter 4")

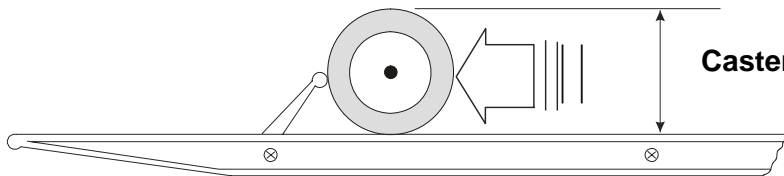

Security instructions when operating the Slidelift

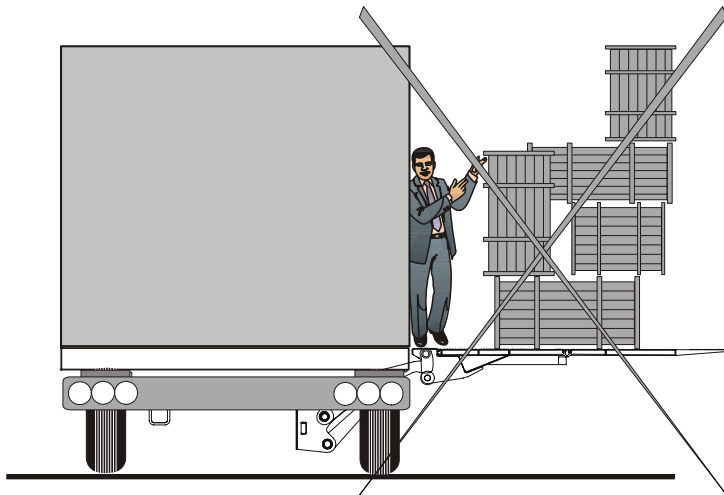

Securing the loads

Secure the loads against tipping and slipping!

Caution at loading docks

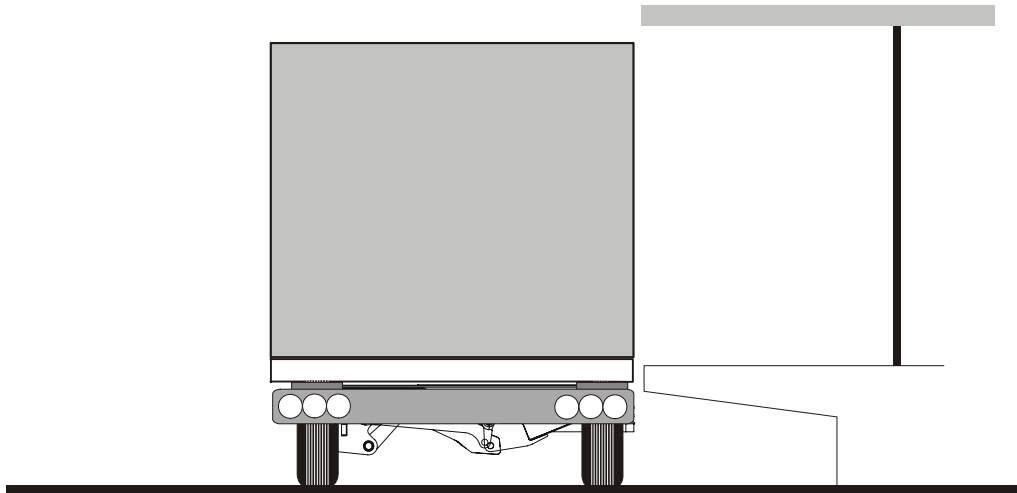

Capacity

In addition to the operating instructions, the Slidelift loading diagram is also shown on its identification plate. The load's centre of gravity should be in the middle between the lift arms. The greater the distance of the load from the end of the flatbed, the lower the loading capacity.

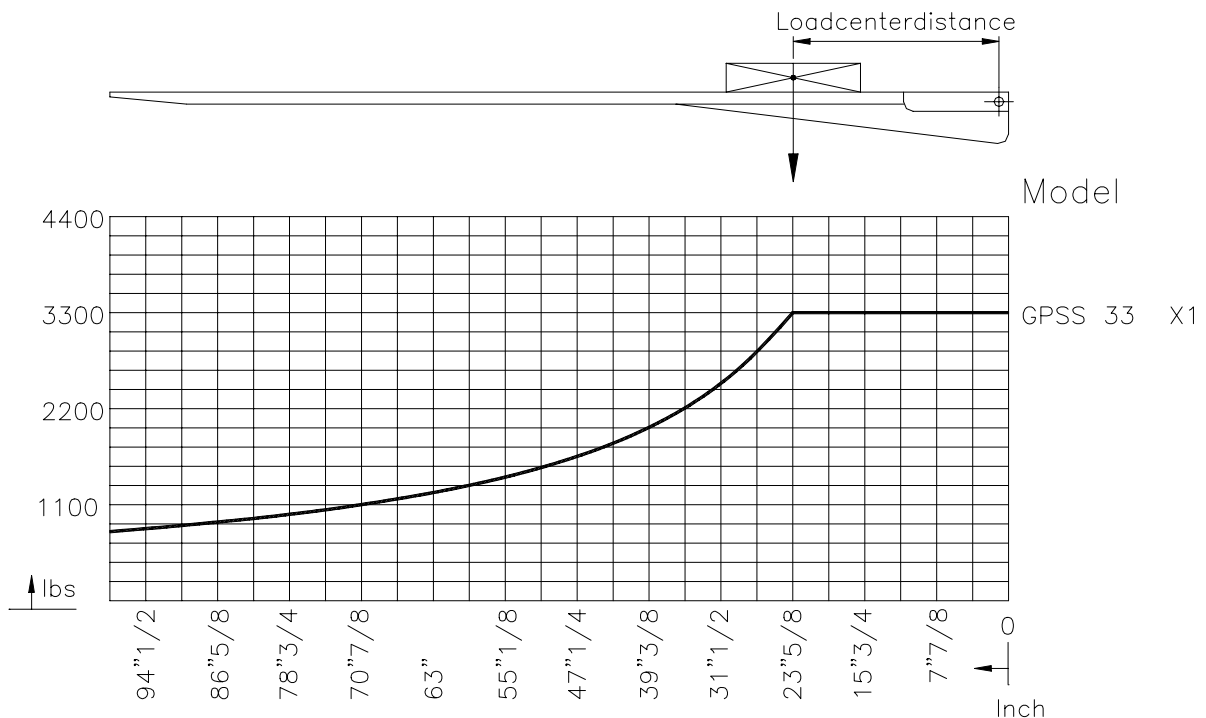

The maximum loading capacity specified in the loading diagram must not be exceeded. The platform may not be used as a bridge plate.

Loading from the truck or trailer onto the platform

It is not possible to protect the Slidelift against loads brought from the vehicle to the platform, that are heavier than its rated capacity, nor against loads which are brought onto the platform at the wrong loading distance. An overload can lead to heavy damage (breaking) of the platform. The operator is responsible for loading the Slidelift according to the loading diagram.

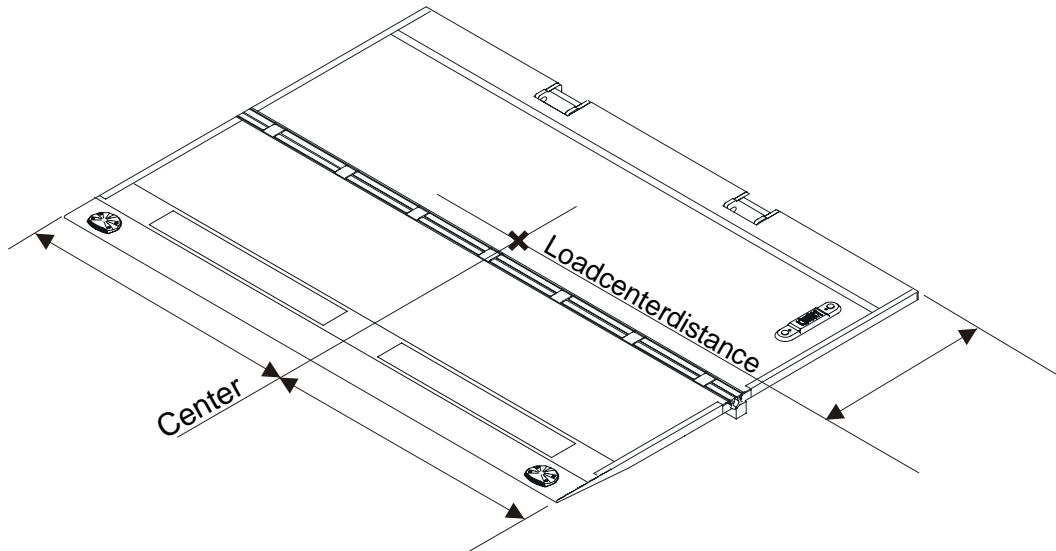

Do not use Platform as a bridge plate

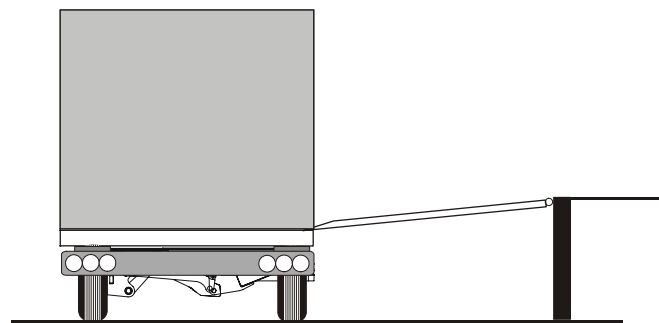
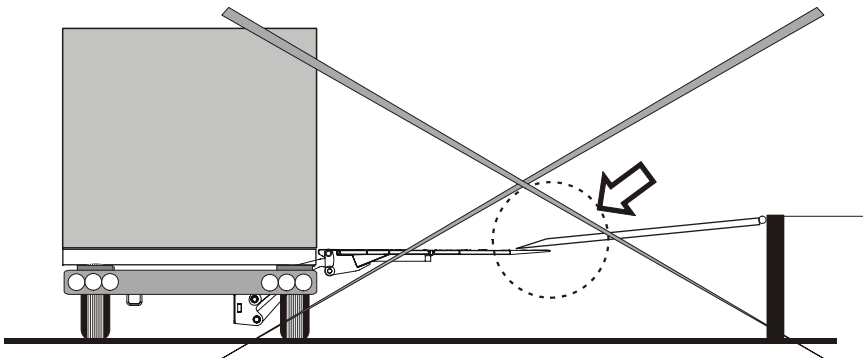

Use trailer or truck body still as load point

Do not use a forklift.

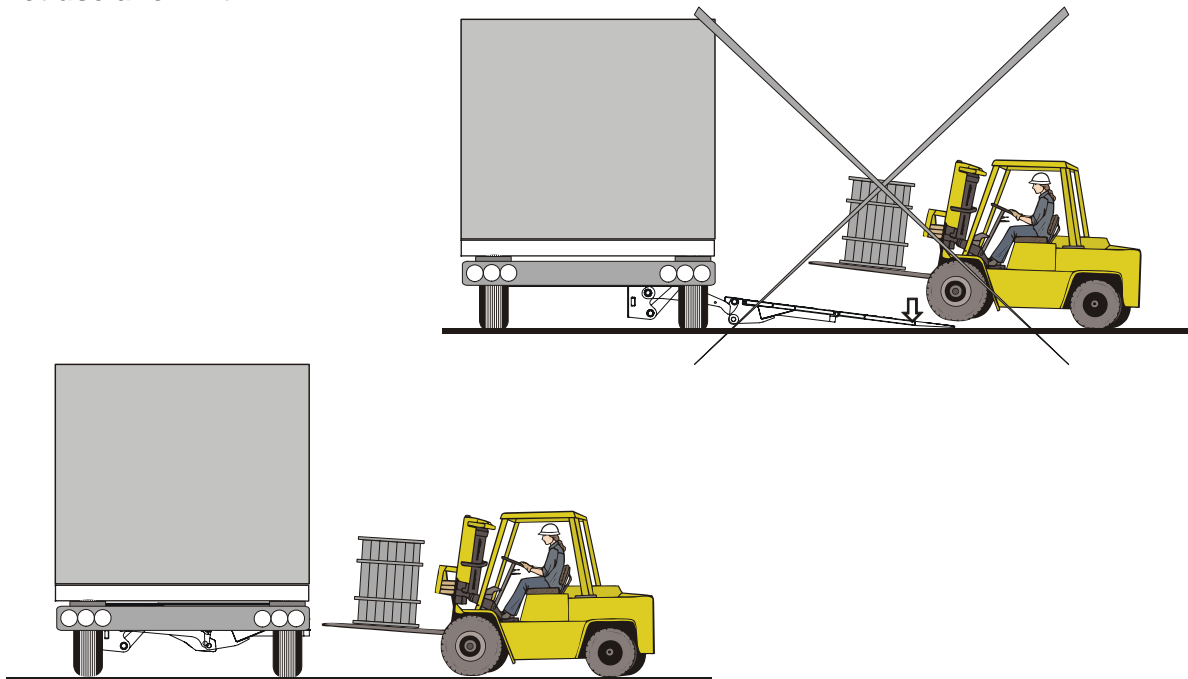

Only when the Slidelift is retracted under the vehicle.

Despite the kind of loading performed, the vehicle has to be secured against unintentional movement (use hand brakes or wedges)

Loading and unloading at a dock

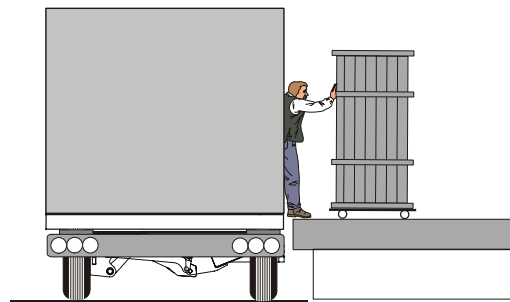
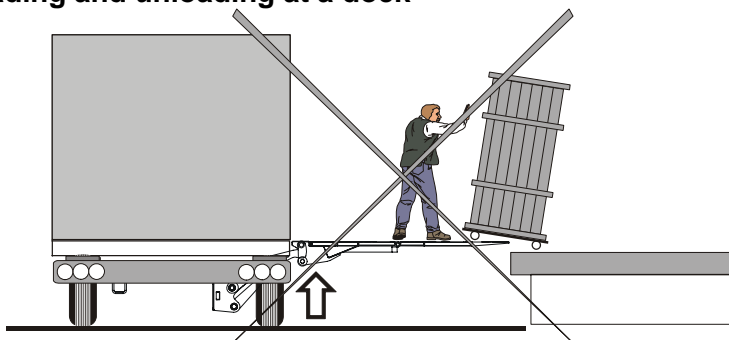

Only when the Slidelift is retracted under the vehicle.

Load transfer from one vehicle to another

During load transfer, do not use the platform as a bridge plate.

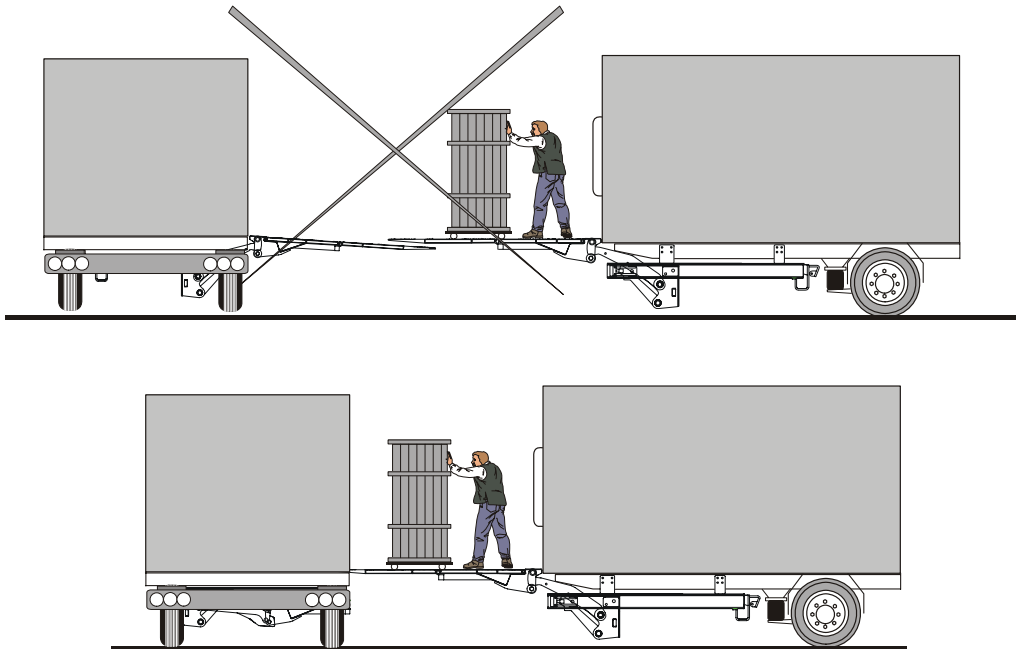

Service, maintenance, verification and repair

Before starting any maintenance work, the Slidelift must be secured against unforeseen movement.

Check that all screw connections are tight. Check that cables and hoses are able to move freely. Correct shearing and chafing points on cables and hoses. Immediately replace damaged hydraulic hoses with ones of the same quality. Note down the replacement in the control book.

During cleaning it should be ensured that no moisture penetrates the power pack or the control box. The bearing areas should not be cleaned with high pressure or steam jets, as this may allow dirt and moisture to penetrate into the bearing. Check all hydraulics for leaks. With the Slidelift platform completely lowered, check the oil level in the unit's tank (dipstick on the oil filler neck cover). If necessary, top up with hydraulic oil of class HLPD 22 (temperature range 5°F to +122°F). The maximum oil level has been reached when the dipstick dips 3/8 " into the oil.

Carry out an annual oil change and clean the suction filter. Carry out the oil change before any period of frost, in order to prevent the hydraulic unit from freezing up.

Hydraulic oil - recommendations

OIL SPECIFICATIONS

Grade ISO - (32)

Gravity, API - 29.5 Degrees

Pour Point, F - (-54 Degrees)

VISCOSITY

@ 40 Degrees C - 31.2 cSt

@ 100 Degrees C - 6.2 cSt

VISCOSITY INDEX - 154 VI

Flash Point, F - 325 Degrees

Repairing bearing elements

Repairs on bearing elements of the Slidelift can only be performed in an authorized service dealer, must be verified by an expert and have to be recorded in the control book.

Defective under ride energy absorbers can not be repaired and must be replaced.

For any malfunctioning, first check voltage level

Troubleshooting

Problem	possible cause
1. Motor of pump box does not turn on	Battery cable or ground cable not connected or defective
	Main fuse defective Fuse in aggregate defective
	The power relay is defective and doesn't activate
	Motor defective
2. Motor does not work on one function only	Toggleswitch on hand control box defective
	Cable from hand control box to pump box defective
	Wiring inside pump box defective
	Switch relay defective (Starter Solenoid)
3. Slidelift does not come out or comes out slowly	Lift stuck on vehicle chassis
	Cable connection to magnetic valves defective
	Magnetic valves on slide cylinders defective
	Bypass inside tilting cylinder defective or blocked
	Solenoid valves
<i>Please refer to wiring diagram attached to this operator's handbook</i>	
4. Slidelift does not lower or lowers very slowly.	Magnetic valves Y3 are not activated or defective

Problem	possible cause
5. Slidelift tilts down instead of lowering.	Switch S4 does not respond
	Cable defective
	Mechanical damage at lift cylinder
6. Platform tilts down alone without operating that function.	Solenoid valves on tilting cylinder defective
7. Platform does not tilt down when touching the ground.	Cable to pressure switch defective
	Pressure switch defective
8. Slidelift does not lift	Pump box does not work
	Lack of oil in the tank
	Voltage insufficient (low Battery)
9. Slidelift does not lift rated capacity	Load is placed in excess of permitted loading distance
	Weight of load too high
	Overload security valve not set properly
	Pump defective
	Voltage insufficient (low Battery)
10. Slidelift does not tilt up from ground when unloaded	Toggleswitch does not operate
	Mercury switch S2 defective or not set properly
	Low voltage
11. Slidelift does not tilt up from ground when loaded.	Load is placed in excess of permitted loading distance
	Weight of load too high
	Low voltage
	Overload security valve not set properly
12. Slidelift tilts from ground above horizontal	Mercury switch S2 defective or not set properly

Solution : Please contact an authorized service dealer and ask for repair or replacement.

If the motor does not stop "Slidelift can not be turned off at all"



Disconnect the cable to the battery plus, or disconnect using battery main switch. In case of an emergency please contact the nearest authorized service dealer or our customers service.

Total failure when slid out

If you perform an emergency lifting of the platform and/or an in- or outsliding of the Slidelift by hand or with mechanical help, the cylinders are filled with air. All security valves are then out of function. This leads to immediate accident and life danger, as the lift can fall on the ground totally uncontrolled. In a case like this, the lift must be secured with ropes or chains and must be marked with a clear sign such as :

Caution ! Life danger ! The Slidelift is unsecured and must be operated only by trained personnel !

Operation failure

In case of failure, please contact our customers service or the next authorized service dealer. We will provide an up-to-date list of service dealers on request
Contact Maxon Technical Service at 1-800-227-4116 or fax 888-771-7713

Warranty

MAXON LIFT CORP.

11921 Slauson Ave.

Santa Fe Springs, CA. 90670

CUSTOMER SERVICE:

(562) 464-0099

(800) 227-4116

FAX: (888) 771-7713

TECHNICAL SERVICE:

(800) 8-MAXTEK (862-9835)

WARRANTY POLICY & PROCEDURE

NEW LIFTGATE WARRANTY

Term of Warranty: 2 Years from Date of In-Service

Type of Warranty: Full Parts and Labor

MAXON agrees to replace any components which are found to be defective during the first 2 years of service, and will reimburse for labor based on Maxon's Liftgate Warranty Flat Rate Labor Schedule.

All claims for warranty must be received within 30 Days of the repair date, and include the following information:

1. Liftgate Model Number
2. Liftgate Serial Number
3. Description of Problem
4. Corrective Action Taken, and Date of Repair.
5. Parts used for Repair, Including MAXON Part Number(s).
6. MAXON R.M.A. # and/or Authorization # if applicable (see below).
7. Person contacted at MAXON if applicable.

PURCHASE PART WARRANTY

Term of Warranty: 1 Year from Date of Purchase Type of Warranty: Part Replacement and Replacement Labor

MAXON will guarantee all returned genuine replacement parts upon receipt, and inspection of parts and invoice. All Warranty repairs must be performed by an authorized MAXON warranty station.

For major repairs, Maxon's Warranty Department must be notified, and an "Authorization Number" received. Major repairs would generally be considered repairs made to the structural assembly of the liftgate and/or repairs not outlined in the Maxon Slidelift Warranty Flat Rate Schedule.

Major components (i.e. hydraulic pumps, cylinders, valves, or failed structural parts) must be returned, freight pre-paid, prior to the claim being processed. To ensure timely processing of these warranty claims, an R.G.A. (Returned Goods Authorization) number must be obtained from Maxon's Warranty Department prior to the return of any defective part. Defective Parts must be returned within 60 days of the claim date for consideration to:

Warranty Department, MAXON Lift Corp.
5920 Alameda St., Huntington Park, CA. 90255

Maxon's warranty policy does not include the reimbursement for travel time; towing; vehicle rental; service calls; fabrication of parts which are available from MAXON; oil; defects due to misuse or abuse; loss of income due to downtime.

Maxon's Flat Rate Labor Schedule times takes into consideration time required for diagnosis of problem.

Warranty and Technical Information is available by calling Maxon's Customer Service Department.

NOTE: Check with Customer Service Department for updated versions of Manuals on an annual basis.

Liability exclusions

Our liability excludes : damages assigned to wrong installation or operation of the Slidelift, overloading, improper use, insufficient battery charge or capacity, accidents or damages due to ground contact (e.g. rough terrain at building sites)

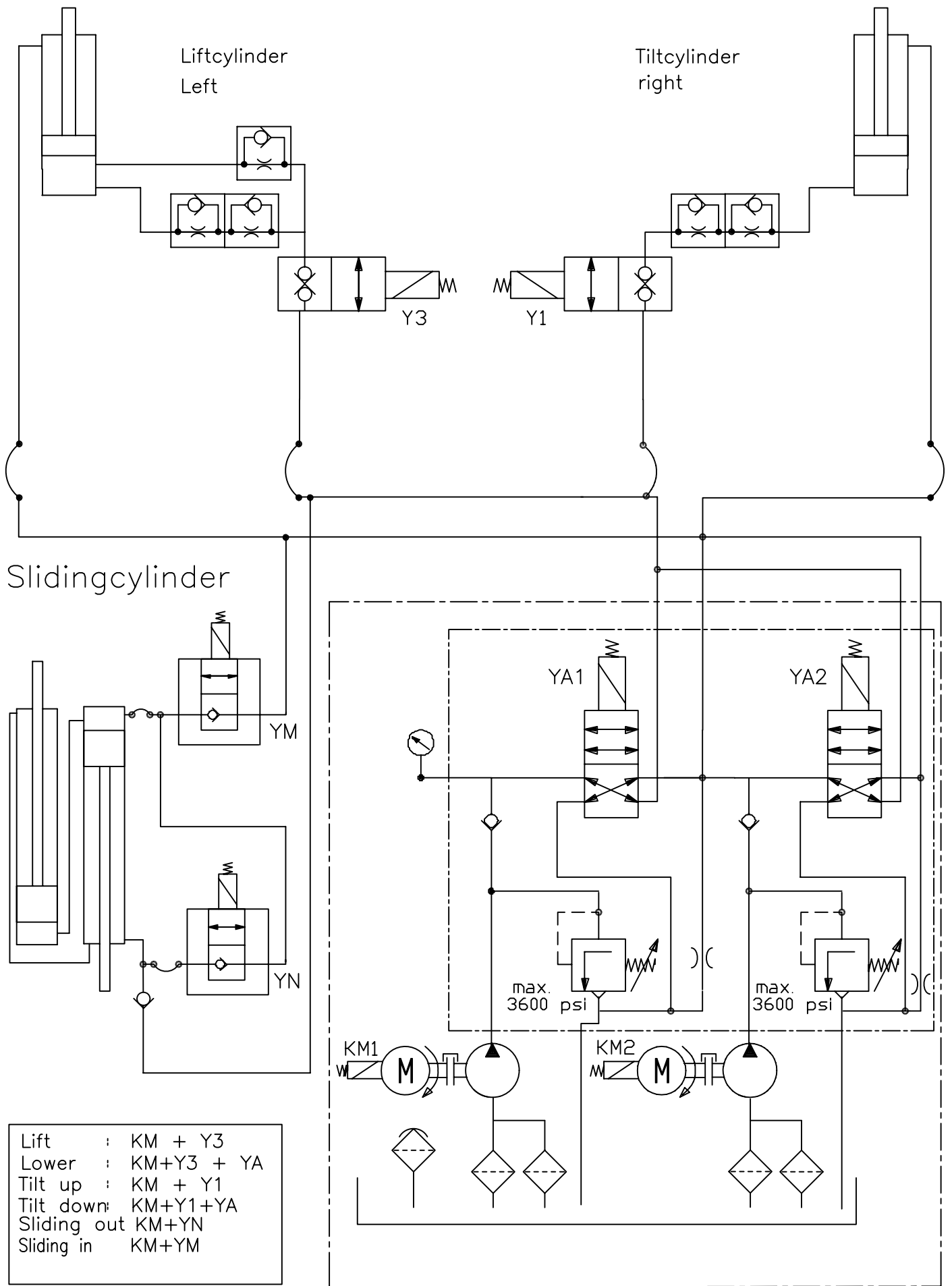

MAXON®

Date: 31.07.02
 Ini: SKC

Nr.: 20 905 846

20 906 378 CONTROL-UNIT GPS 12 V

left lamp is out, if FH is pressed and S2 switched at horizontal platform position.
 left lamp is out also, if FS is pressed and S4 switched if platform is on ground (lift-cylinder is without pressure).
 right lamp is out, if foot switch FH or FS is pressed or handheld controlbox is in use.

	YM	YN	KM	YA	Y1	Y3	S2	S4
LIFT	X				X			
LOWER	X			X		X		
TILT-UP	X			X		X		
TILT-DOWN	X			X		X		
DRIVE IN	X			X		X		
DRIVE OUT	X			X		X		
TILT-UP	X			X		X		X
LIFT	X			X		X		X
LOWER	X			X		X		X
TILT-DOWN	X			X		X		X

CONTROLBOX
 HANDHELD CONTROL

HANDHELD CONTROLBOX
 20 906 387

1 - lift
 2 - lower
 3 - + (gr/ye)

SWITCH
 POWER-PACK 1
 POWER-PACK 2

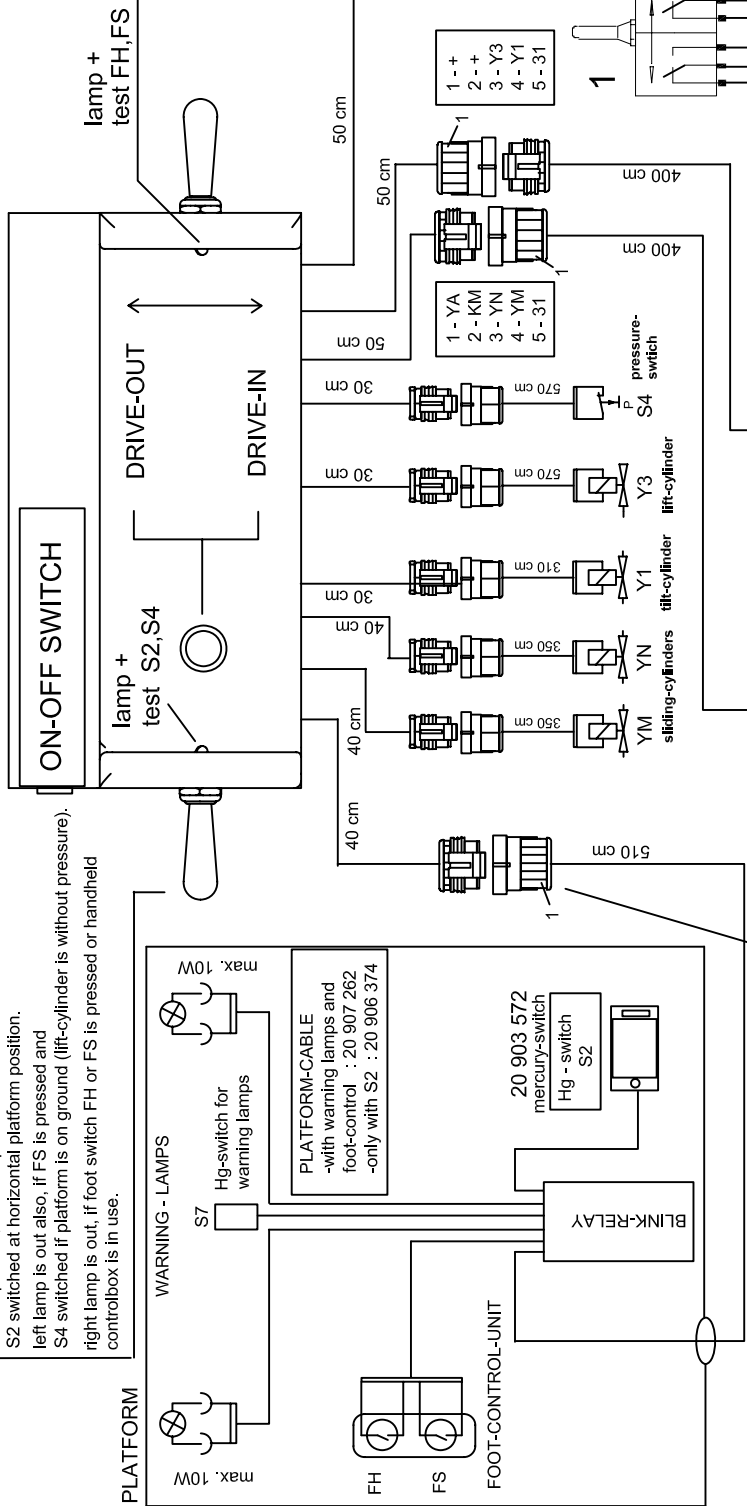

- 1 - +
- 2 - FH
- 3 - FS
- 4 - S2
- 5 - 31
- 6 - frei

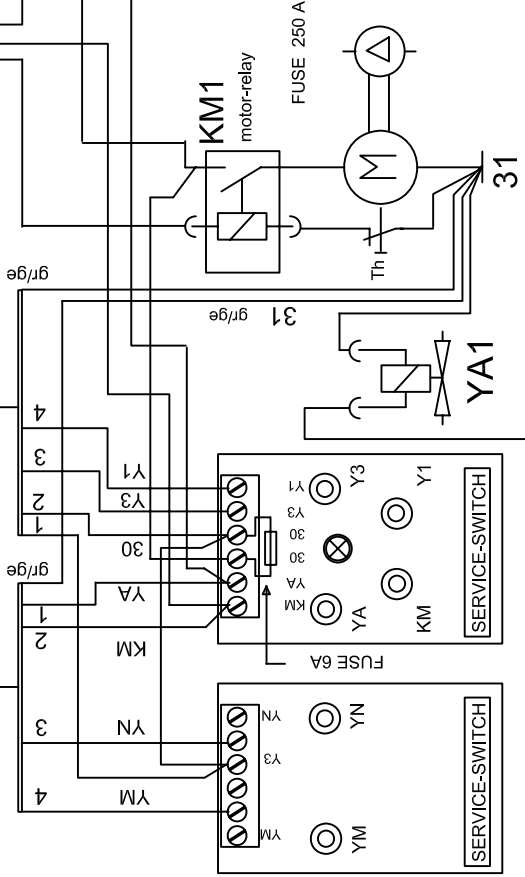

POWER-PACK

- 30 - batteryplus
- 31 - batteryminus
- KM - motorrelay
- YA - solenoid in power-pack
- Y1 - solenoid tilt-cylinder
- Y3 - solenoid lift-cylinder
- YM - solenoid sliding-cylinder
- YN - solenoid sliding-cylinder
- S2 - Hg-switch lift
- S4 - pressure-switch tilt down
- S7 - Hg-switch warning lamps
- Th - motor-thermoswitch
- FH - footcontrol lift
- FS - footcontrol lower



SERIE X1
 CONTROL-UNIT GPS / GPSS
 DATUM: 8.10.2003
 gez.: W.Bassen

Nr.: 20 907 148