

INSTRUCTIONS, C2 LIGHT KIT
RECTANGULAR LIGHT KIT (4 LIGHTS, 2 RED, 2 WHITE, INCANDESCENT)
COMBINED STOP & TURN (T-57)
P/N 295555-01

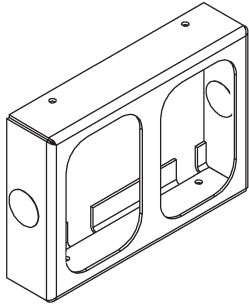

**HOUSING BOX,
2 RECTANGULAR LIGHTS**
P/N 295551-02
QTY. 2

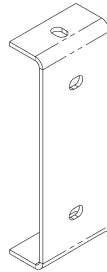

BOLT-ON LIGHT BRACKET
P/N 295552-01
QTY. 4

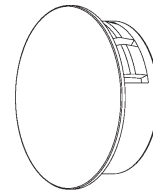

NYLON PLUG, 1-1/4"
P/N 908081-06
QTY. 4

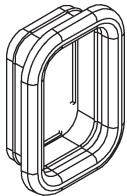

GROMMET, RECTANGULAR LAMP
P/N 908239-01
QTY. 4



**BACKUP LAMP,
INCANDESCENT, 12V**
P/N 907239-01
QTY. 2



**STOP & TURN LAMP, INCANDESCENT,
12V**
P/N 907238-01
QTY. 2



**GROMMET, 1.0" DIA. DIAPHRAGM,
1/2" DIA. HOLE**
P/N 266428-05
QTY. 2

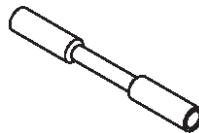

BUTT SPLICE
P/N 263891
QTY. 10

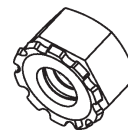

MACHINE SCREW NUT, 1/4"-20
P/N 903163-01
QTY. 12

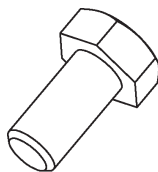

SCREW, HEX CAP, 1/4"-20 X 3/4" LG.
P/N 900788-02
QTY. 12

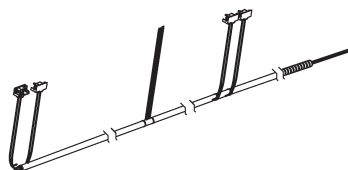

**4 LIGHT HARNESS,
COMBINED STOP & TURN**
P/N 295558-01
QTY. 1



DECAL, WARNING, NO STEP
P/N 288963-01
QTY. 2

**RECTANGULAR LIGHT KIT (6 LIGHTS, 4 RED, 2 WHITE, INCANDESCENT)
COMBINED STOP & TURN (T-57)
P/N 295555-02**

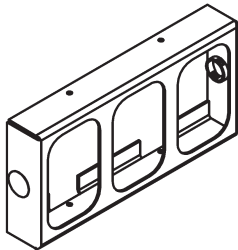

**HOUSING BOX,
3 RECTANGULAR LIGHTS
P/N 295551-01
QTY. 2**

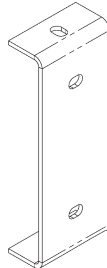

**BOLT-ON LIGHT BRACKET
P/N 295552-01
QTY. 4**

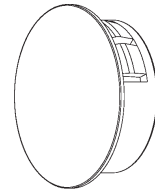

**NYLON PLUG, 1-1/4"
P/N 908081-06
QTY. 4**

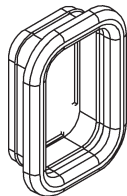

**GROMMET, RECTANGULAR LAMP
P/N 908239-01
QTY. 6**

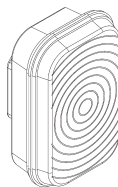

**BACKUP LAMP,
INCANDESCENT, 12V
P/N 907239-01
QTY. 2**

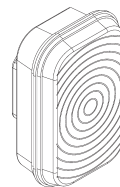

**STOP & TURN LAMP, INCANDESCENT,
12V
P/N 907238-01
QTY. 4**



**GROMMET, 1.0" DIA. DIAPHRAGM,
1/2" DIA. HOLE
P/N 266428-05
QTY. 2**

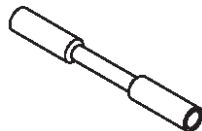

**BUTT SPLICE
P/N 263891
QTY. 10**

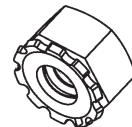

**MACHINE SCREW NUT, 1/4"-20
P/N 903163-01
QTY. 12**

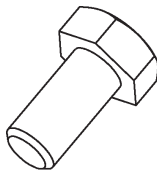

**SCREW, HEX CAP, 1/4"-20 X 3/4" LG.
P/N 900788-02
QTY. 12**

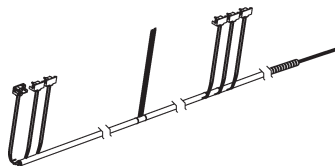

**6 LIGHT HARNESS,
COMBINED STOP & TURN
P/N 295558-02
QTY. 1**



**DECAL, WARNING, NO STEP
P/N 288963-01
QTY. 2**

**RECTANGULAR LIGHT KIT (4 LIGHTS, 2 RED, 2 WHITE, LED)
COMBINED STOP & TURN (T-57)
P/N 29555-03**

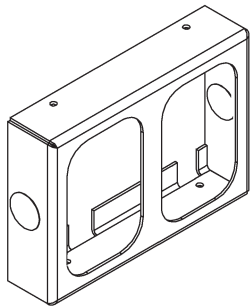

**HOUSING BOX,
2 RECTANGULAR LIGHTS
P/N 295551-02
QTY. 2**

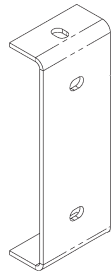

**BOLT-ON LIGHT BRACKET
P/N 295552-01
QTY. 4**

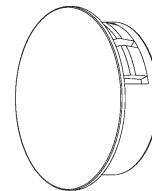

**NYLON PLUG, 1-1/4"
P/N 908081-06
QTY. 4**

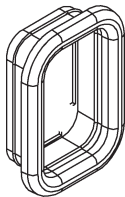

**GROMMET, RECTANGULAR LAMP
P/N 908239-01
QTY. 4**



**BACKUP LAMP, LED,
CLEAR, 12V
P/N 907237-01
QTY. 2**



**STOP & TURN LAMP, LED, RED, 12V
P/N 907236-01
QTY. 2**



**GROMMET, 1.0" DIA. DIAPHRAGM,
1/2" DIA. HOLE
P/N 266428-05
QTY. 2**

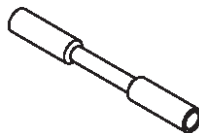

**BUTT SPLICE
P/N 263891
QTY. 10**

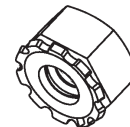

**MACHINE SCREW NUT, 1/4"-20
P/N 903163-01
QTY. 12**

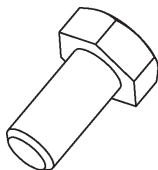

**SCREW, HEX CAP, 1/4"-20 X 3/4" LG.
P/N 900788-02
QTY. 12**

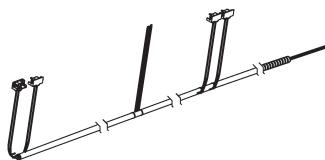

**4 LIGHT HARNESS,
COMBINED STOP & TURN
P/N 295558-01
QTY. 1**

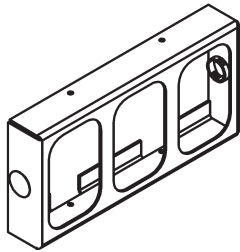
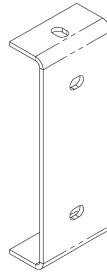
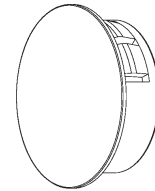
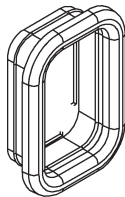
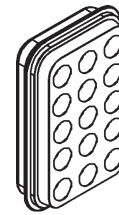
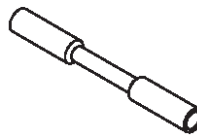
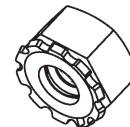
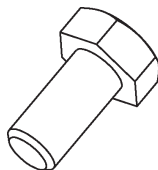
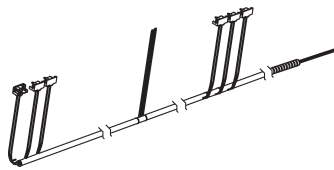

**DECAL, WARNING, NO STEP
P/N 288963-01
QTY. 2**

**RECTANGULAR LIGHT KIT (6 LIGHTS, 4 RED, 2 WHITE, LED)
COMBINED STOP & TURN (T-57)****P/N 295555-04****HOUSING BOX,
3 RECTANGULAR LIGHTS
P/N 295551-01
QTY. 2****BOLT-ON LIGHT BRACKET
P/N 295552-01
QTY. 4****NYLON PLUG, 1-1/4"
P/N 908081-06
QTY. 4****GROMMET, RECTANGULAR LAMP
P/N 908239-01
QTY. 6****BACKUP LAMP, LED,
CLEAR, 12V
P/N 907237-01
QTY. 2****STOP & TURN LAMP, LED, RED, 12V
P/N 907236-01
QTY. 4****GROMMET, 1.0" DIA. DIAPHRAGM,
1/2" DIA. HOLE
P/N 266428-05
QTY. 2****BUTT SPLICE
P/N 263891
QTY. 10****MACHINE SCREW NUT, 1/4"-20
P/N 903163-01
QTY. 12****SCREW, HEX CAP, 1/4"-20 X 3/4" LG.
P/N 900788-02
QTY. 12****6 LIGHT HARNESS,
COMBINED STOP & TURN
P/N 295558-02
QTY. 1****DECAL, WARNING, NO STEP
P/N 288963-01
QTY. 2**

**RECTANGULAR LIGHT KIT (6 LIGHTS, 4 RED, 2 WHITE, INCANDESCENT)
SEPARATED STOP & TURN (T-57)
P/N 295555-06**

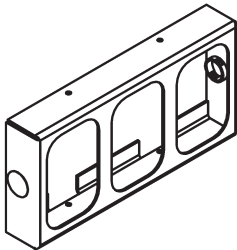

**HOUSING BOX,
3 RECTANGULAR LIGHTS
P/N 295551-01
QTY. 2**

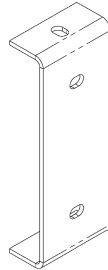

**BOLT-ON LIGHT BRACKET
P/N 295552-01
QTY. 4**

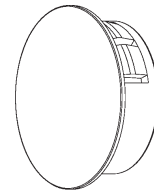

**NYLON PLUG, 1-1/4"
P/N 908081-06
QTY. 4**

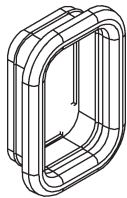

**GROMMET, RECTANGULAR LAMP
P/N 908239-01
QTY. 6**



**BACKUP LAMP,
INCANDESCENT, 12V
P/N 907239-01
QTY. 2**

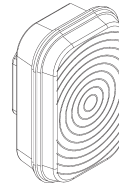

**STOP & TURN LAMP, INCANDESCENT,
12V
P/N 907238-01
QTY. 4**



**GROMMET, 1.0" DIA. DIAPHRAGM,
1/2" DIA. HOLE
P/N 266428-05
QTY. 2**

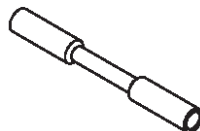

**BUTT SPLICE
P/N 263891
QTY. 10**

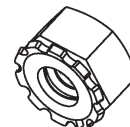

**MACHINE SCREW NUT, 1/4"-20
P/N 903163-01
QTY. 12**

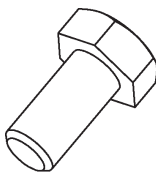

**SCREW, HEX CAP, 1/4"-20 X 3/4" LG.
P/N 900788-02
QTY. 12**

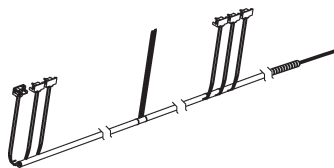

**6 LIGHT HARNESS,
SEPARATED STOP & TURN
P/N 295558-04
QTY. 1**



**DECAL, WARNING, NO STEP
P/N 288963-01
QTY. 2**

**RECTANGULAR LIGHT KIT (6 LIGHTS, 4 RED, 2 WHITE, LED)
SEPARATED STOP & TURN (T-57)
P/N 295555-08**

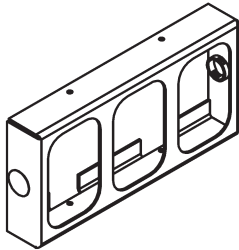

**HOUSING BOX,
3 RECTANGULAR LIGHTS
P/N 295551-01
QTY. 2**

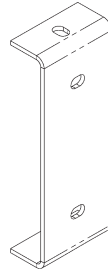

**BOLT-ON LIGHT BRACKET
P/N 295552-01
QTY. 4**

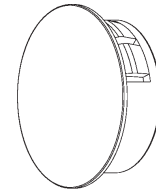

**NYLON PLUG, 1-1/4"
P/N 908081-06
QTY. 4**

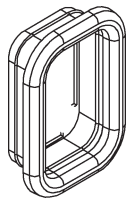

**GROMMET, RECTANGULAR LAMP
P/N 908239-01
QTY. 6**



**BACKUP LAMP, LED,
CLEAR, 12V
P/N 907237-01
QTY. 2**

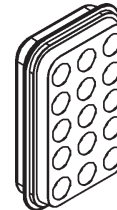

**STOP & TURN LAMP, LED, RED, 12V
P/N 907236-01
QTY. 4**



**GROMMET, 1.0" DIA. DIAPHRAGM,
1/2" DIA. HOLE
P/N 266428-05
QTY. 2**

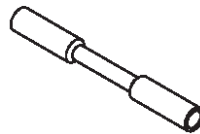

**BUTT SPLICE
P/N 263891
QTY. 10**

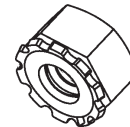

**MACHINE SCREW NUT, 1/4"-20
P/N 903163-01
QTY. 12**

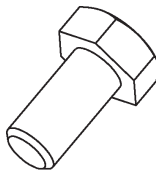

**SCREW, HEX CAP, 1/4"-20 X 3/4" LG.
P/N 900788-02
QTY. 12**

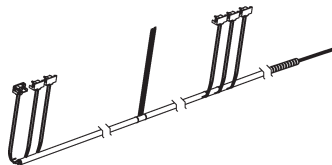

**6 LIGHT HARNESS,
SEPARATED STOP & TURN
P/N 295558-04
QTY. 1**



**DECAL, WARNING, NO STEP
P/N 288963-01
QTY. 2**

⚠ WARNING

Remove all rings, watches and jewelry before doing any electrical work.

⚠ WARNING

To prevent accidental personal injury and equipment damage, disconnect (-) battery cable from battery.

⚠ WARNING

Never route an energized wire. Make sure battery is disconnected. Always route electrical wires clear of moving parts, brake lines, sharp edges and exhaust systems. Avoid making sharp bends in wiring. Attach securely. If drilling is necessary, first check behind the drilling surface so you do not damage any fuel lines, vent lines, brake lines or wires.

1. Lower liftgate to ground (FIG. 7-1).

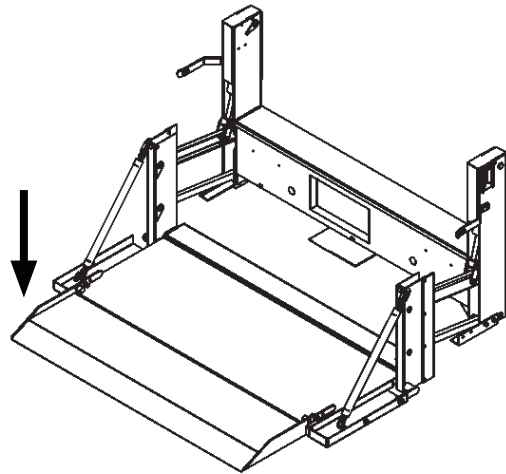

**LOWERING LIFTGATE TO GROUND
FIG. 7-1**

2. Disconnect power to liftgate by disconnecting negative (-) battery cable from battery (-) terminal (FIG.7-2).

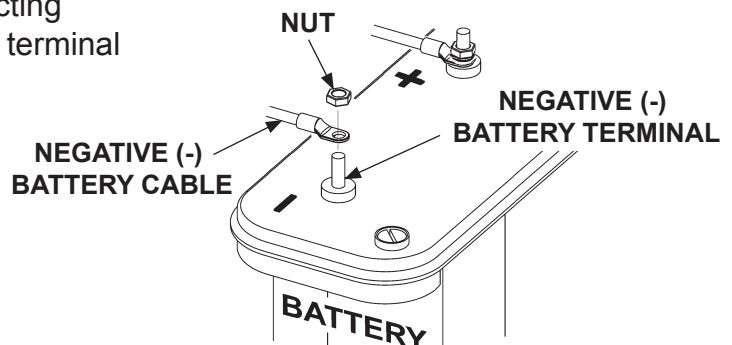

**DISCONNECTING POWER
FIG. 7-2**

3. Unbolt the main frame box cover by removing three 5/16" hex nuts (**FIG. 8-1**).

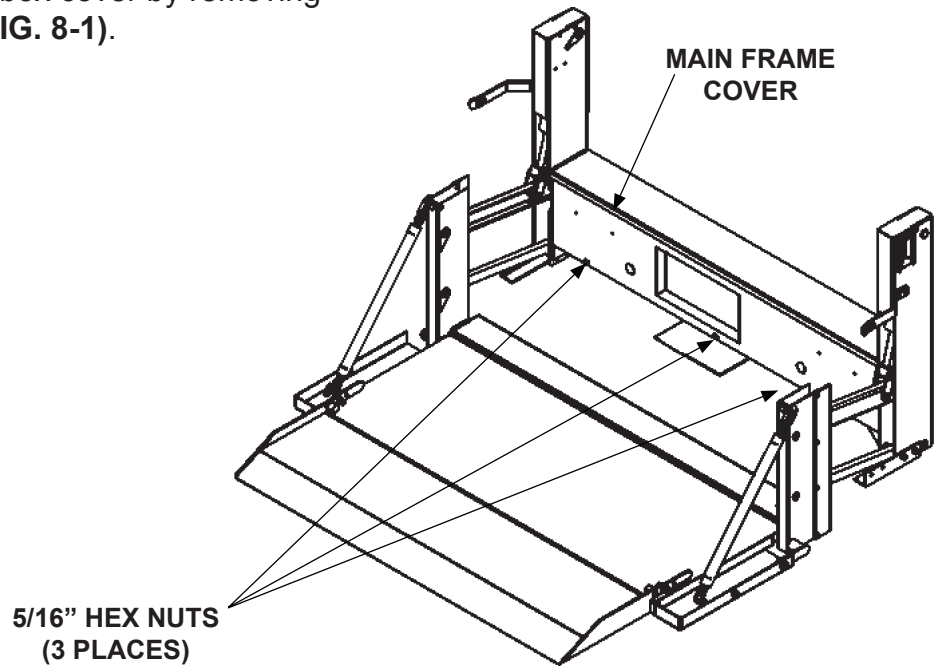

UNBOLTING MAIN FRAME COVER
FIG. 8-1

4. Remove two 1-1/4" and four 1/4" plastic plugs from access holes in the main frame cover (**FIG. 8-2**).

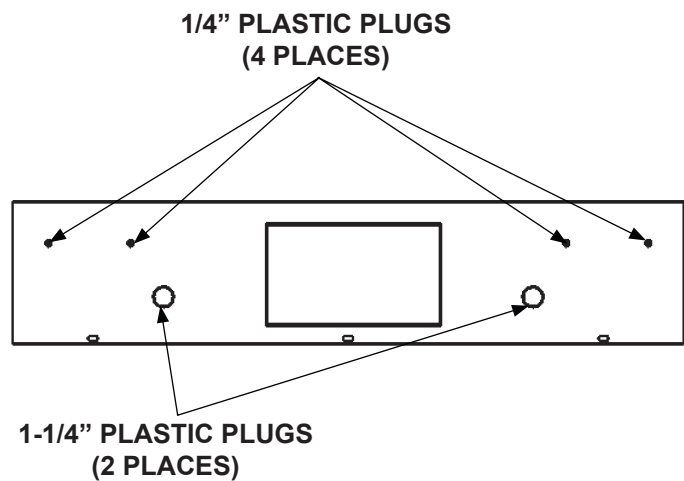

REMOVING PLASTIC PLUGS
FIG. 8-2

NOTE: Ensure that the light connector with the **YELLOW** wire is routed through the driver's side of the cover. Route the light connector with the **GREEN** wire on the passenger's side of the cover.

NOTE: Leave harness draped loosely in main frame until all components are installed.

5. Pull two 2-prong light connectors and one 3-prong light connector through each 1-1/4" access hole (**FIG. 9-1**).

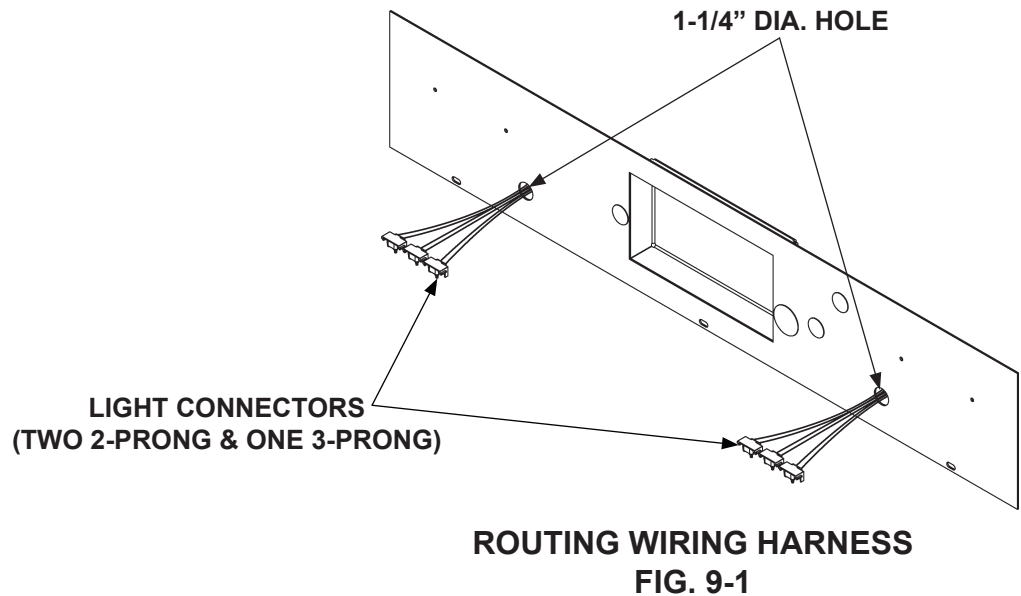

6. On the taillights harness, locate the two **ORANGE** wires and two **WHITE** wires without connectors.
7. Connect one **ORANGE** wire on the taillights harness to the **BLACK** wire on the license plate light using a heat-shrink butt connector (**FIG. 10-1**).

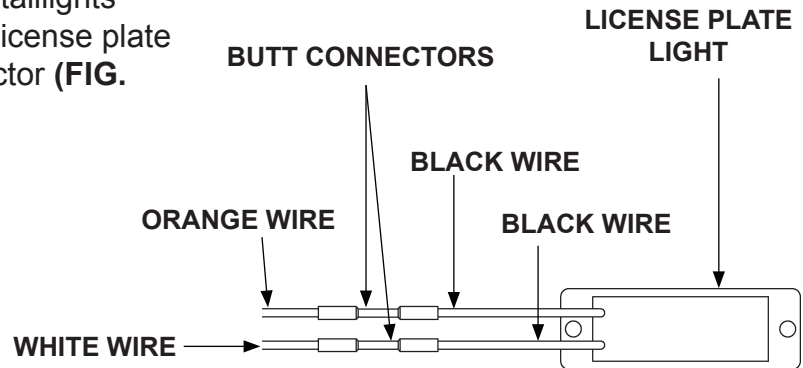

CONNECTING LICENSE PLATE LIGHT
FIG. 10-1

8. Connect one **WHITE** wire on the taillights harness to the **BLACK** wire on the license plate light using a heat-shrink butt connector (**FIG. 10-1**).
9. Bend the unused **ORANGE** and **WHITE** wires as shown in **FIG. 10-2** and wrap the exposed ends with heat shrink tubing.

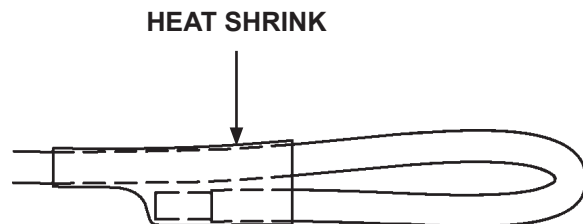

HEAT SHRINKING WIRES
FIG. 10-2

10. Cut the 1-1/4" grommets (Kit item) from the center hole to the outside of grommet (FIG. 11-1A).

11. Place the 1-1/4" grommets around wires and push the grommets into the access holes (FIG. 11-1).

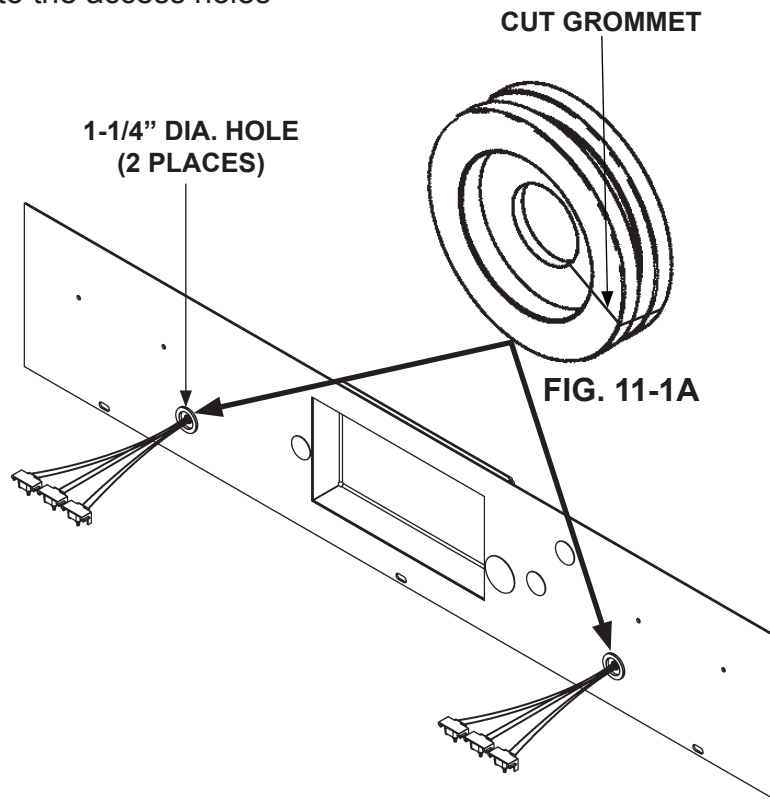

INSTALLING RUBBER GROMMETS
FIG. 11-1

NOTE: Before attaching the light kit to the cover, route the wire harness through the back of the light kit and ensure that no wires are pinched.

NOTE: Ensure that the WARNING decal is facing up before attaching the light kit to the cover.

12. Bolt the light brackets and housings (Kit items) to main frame cover using 1/4"-20 X 3/4" bolts and 1/4"-20 nuts (Kit items) (FIG. 12-1). Torque all bolts to **9 lb-ft.**

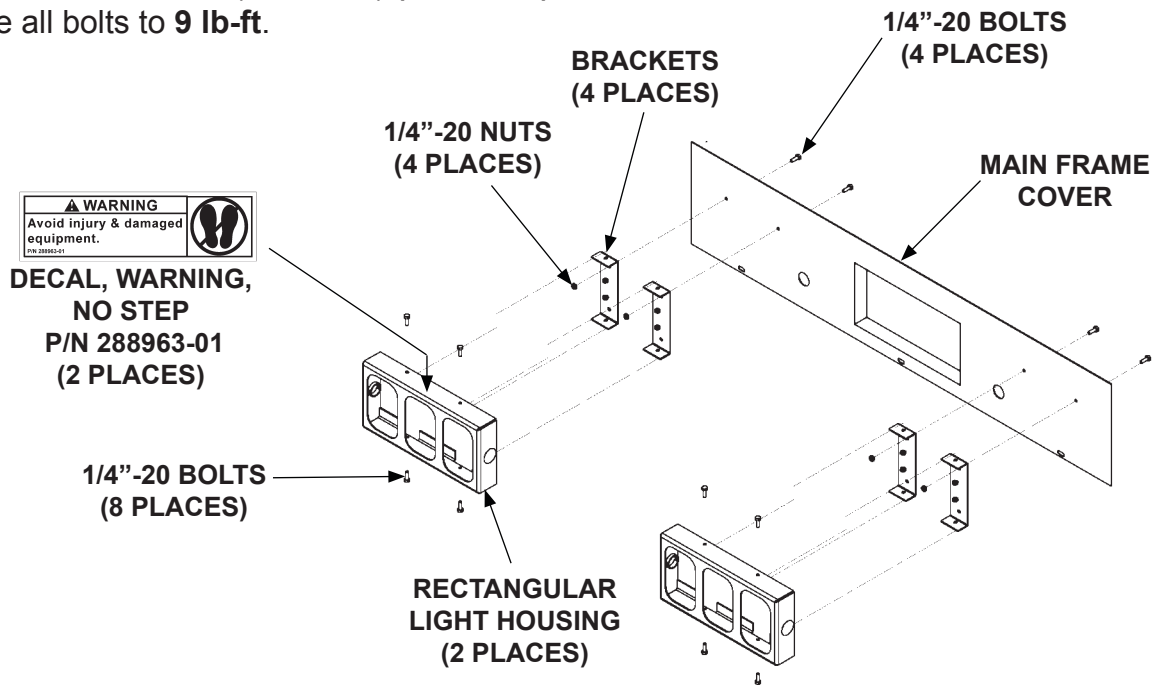

**INSTALLING LIGHT KIT
FIG. 12-1**

13. Press rubber grommets into rectangular holes in light housing (**FIG. 13-1**).

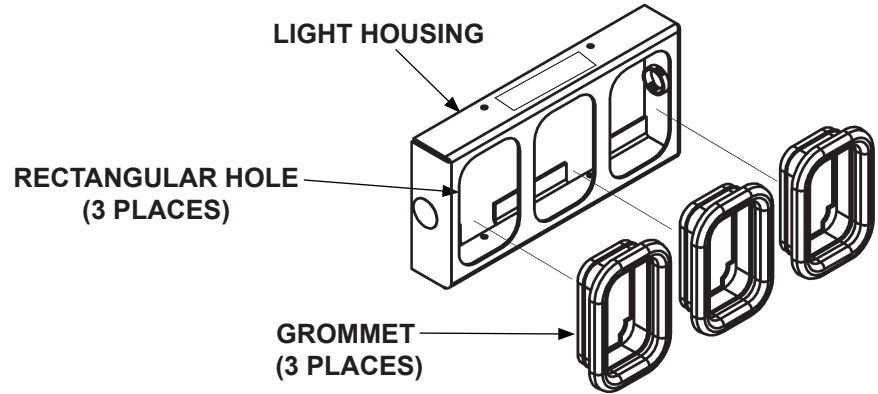

**INSTALLING GROMMETS INTO LIGHT HOUSING (6 LIGHT KIT SHOWN)
FIG. 13-1**

14. Pull harness connectors through grommets and connect to each light (**FIG. 13-2**).

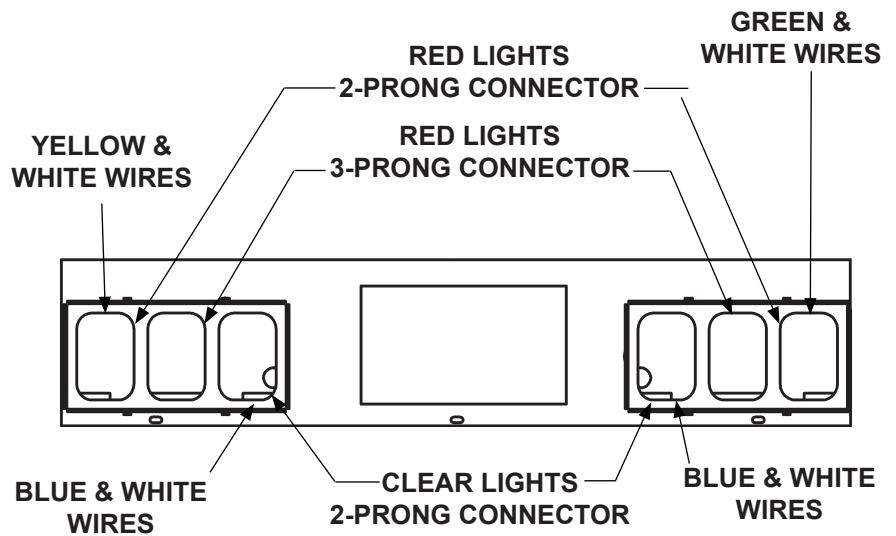

**CONNECTING LIGHTS
FIG. 13-2**

15. Connect light kit wiring harness to the vehicle's existing wiring.

16. Reconnect power to liftgate battery by connecting negative (-) battery cable to battery (-) terminal (FIG. 14-1).

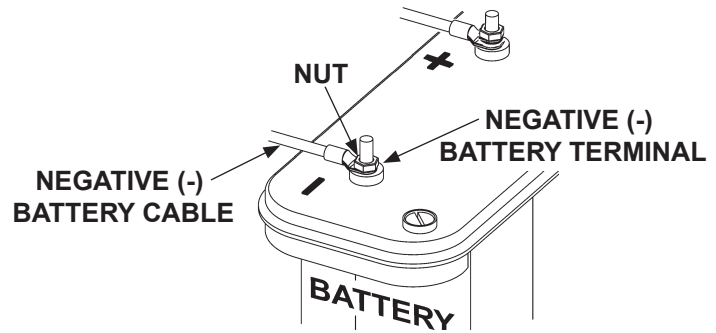

RE-CONNECTING POWER
FIG. 14-1

17. Check for proper operation of lights.
18. If lights operate correctly, push lights into rubber grommets (FIG. 14-2).

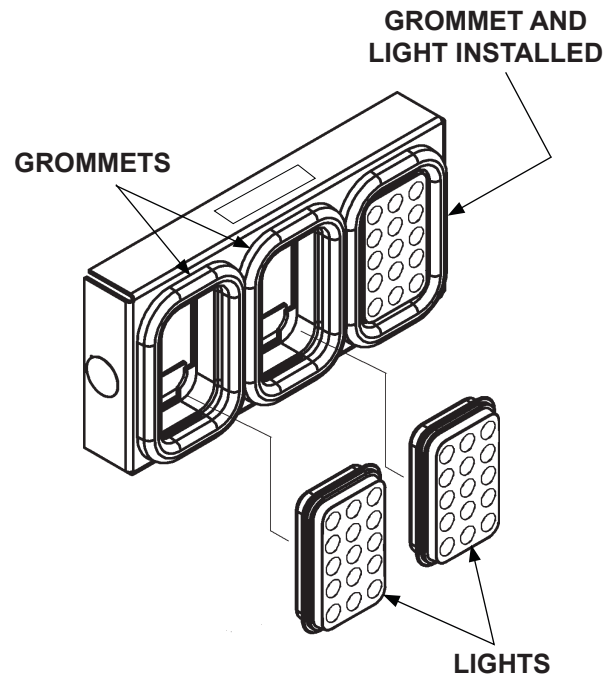

INSERTING LIGHTS INTO GROMMETS
(LED LIGHTS SHOWN)
FIG. 14-2

19. Use plastic ties to secure harness away from moving parts.

20. Bolt main frame cover to Liftgate (FIG. 15-1).

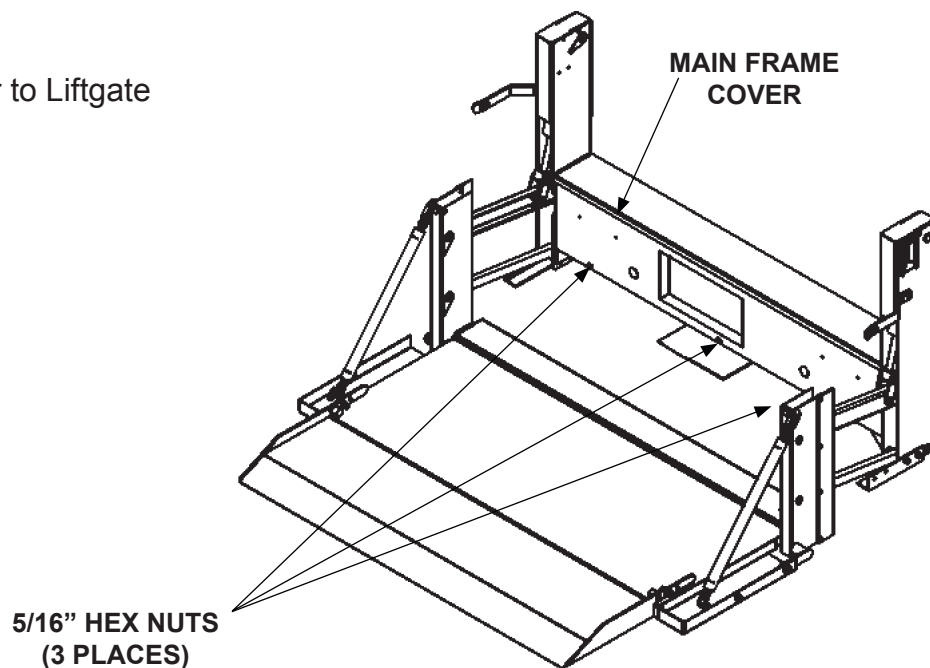

**BOLTING ON MAIN FRAME COVER
FIG. 15-1**

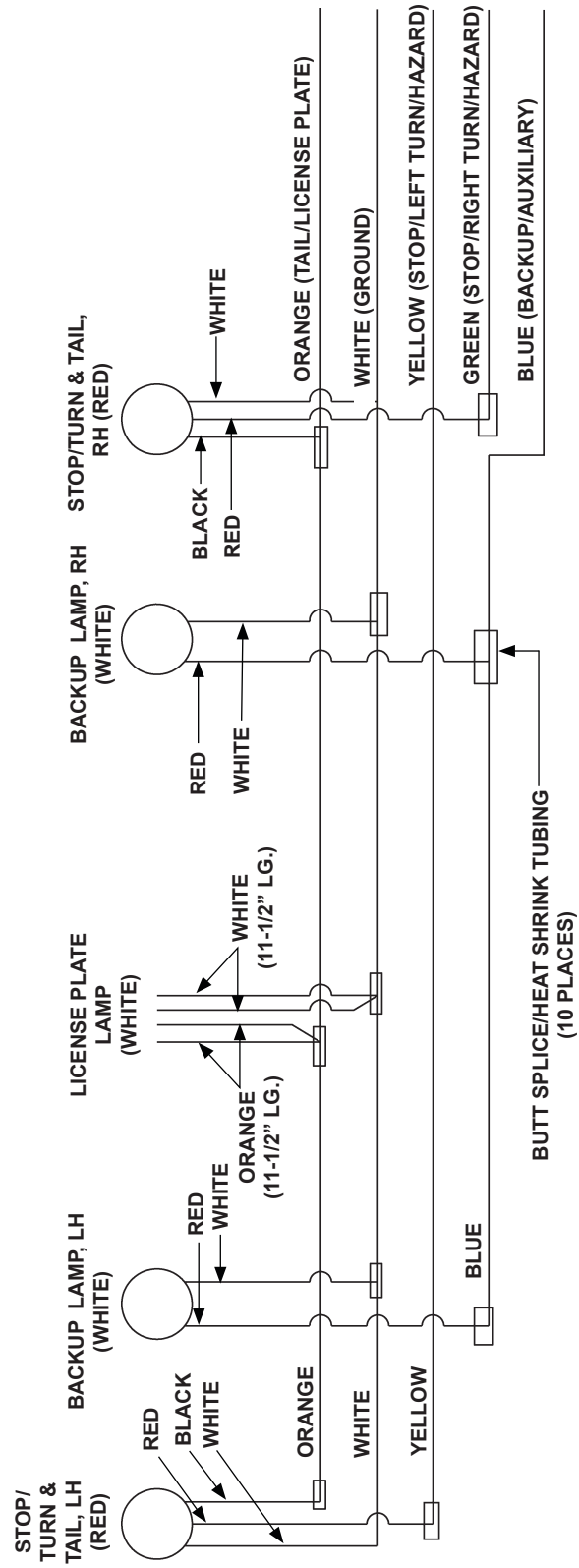

**ELECTRICAL DIAGRAM - 4 LIGHT COMBINED STOP/TURN (INCANDESCENT)
(P/N 295558-01 SHOWN)**

FIG. 16-1

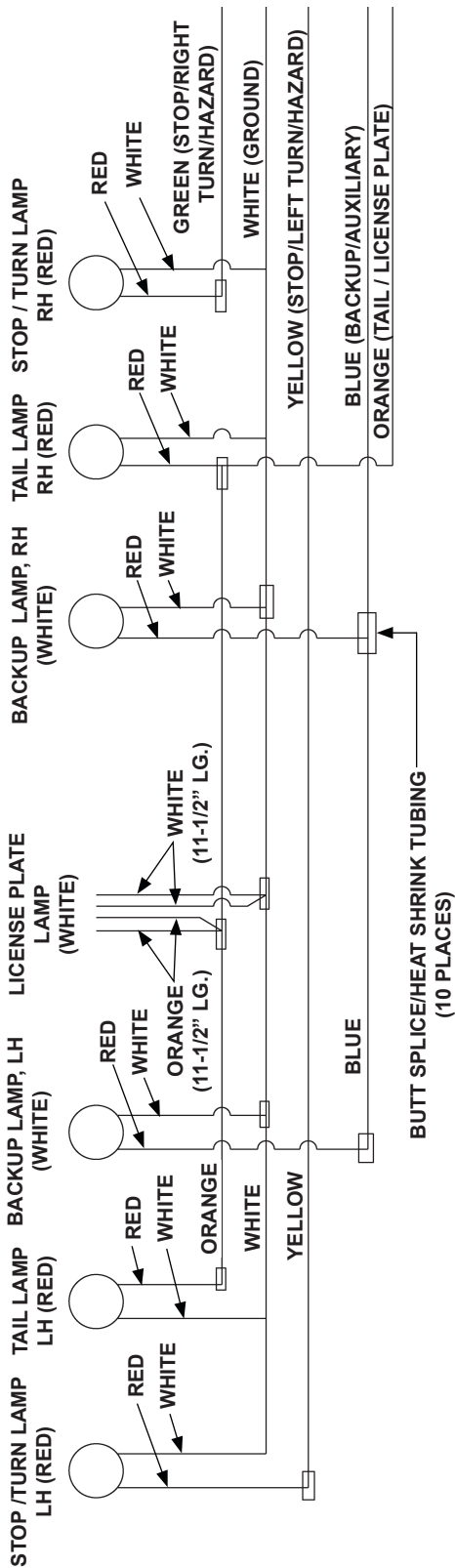

**ELECTRICAL DIAGRAM - 6 LIGHT COMBINED STOP/TURN (INCANDESCENT)
(P/N 295558-02 SHOWN)**

FIG. 17-1

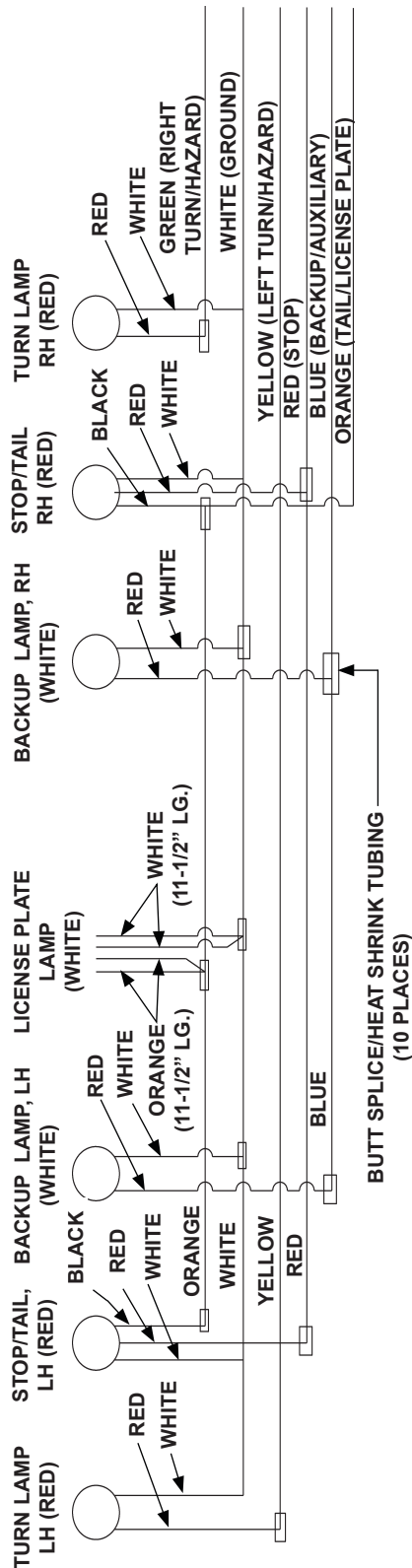

**ELECTRICAL DIAGRAM - 6 LIGHT SEPARATED STOP/TURN (LED)
(P/N 295558-04 SHOWN)**

FIG. 18-1