

TUK-A-WAY® SERIES

The GPTWR-25, GPTWR-3, GPTWR-4, GPTWR-5 Series



GPTWR SPECIFICATIONS

The GPTWR series Tuk-A-Way is the #1 selling liftgate series in the world. The *newly updated GPTWR* now offers a bolt-on extension plate and steps (with and w/o lights). The large aluminum platform makes it ideal for almost every application including large carts or pallets. The Level Ride design keeps the driver and cargo safe and the lightweight aluminum finish will look great for years to come.

- Walk Ramp Ready
- Rust proof extruded all aluminum 60"D X 80"W lightweight platform provides ample size without the increased weight of older steel designs
- Recessed hinge design provides flat loading surface over entire width of platform
- Bolt-on extension plate and steps
- Potted toggle switch
- Power down and power tilt
- MAX GRIP® and Cycle Counter standard
- **Galvanized Finish – STANDARD!**

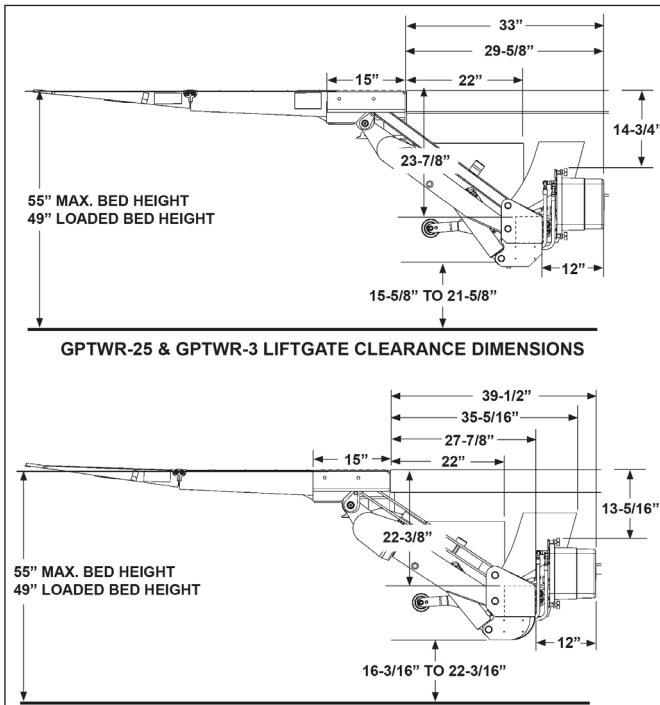

GPTWR Lift Dimensions and Mounting Requirements

NOTE: Please review appropriate liftgate installation manual for full vehicle and or body requirements to ensure proper fitment.

MODEL CAPACITY	OVERALL WEIGHT	PLATFORM SIZE	BED HEIGHT
GPTWR-25 (2500 Lbs.)	(1105 LBS.)	60" X 80"	49" Laden 55" Unladen
GPTWR-3 (3000 Lbs.)	(1115 LBS.)		
GPTWR-4 (4000 Lbs.)	(1130 LBS.)		
GPTWR-5 (5000 Lbs.)	(1140 LBS.)		



TUK-A-WAY® SERIES

The GPTWR-25, GPTWR-3, GPTWR-4, GPTWR-5 Series

MAXON®

Standard Equipment

- Galvanized Standard
- SmartSpace
- Bolt-on Step & Extension Plate (note: can also be welded to the body)
- Extruded All Aluminum Platform
- Power Down & Power Tilt
- Hydraulic Lock Valve
- Recessed Platform Hinge
- Greasable Pins with Zerk Fittings on All Major Pivot Points
- 14" Long Rubber or 13.5" Plastic Dock Bumper
- MAX GRIP® and Cycle Counter

Optional Features

- 2-Step Bolt-On HD Dock Bumpers w/ Light Cut Outs
- Flexible Cable Steps
- Automatic Cart Stops (Single or Dual)
- Cab Cut Off Switch
- Hand Held Remote
- Max On-Lok® (Dock Lock Receiver-by Special Order Request)
- FMVSS and CMVSS Certified Underride
- Flashing Lights

Loadable Platform Space with Cart Stops Deployed

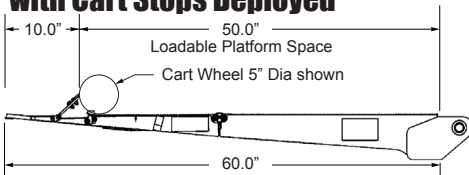

Distributed by:



SmartSpace

Maxon has added a gap (SmartSpace) between the liftgate and the extension plate. This feature makes liftgates more efficient and safe to use.



Bolt-On Extension Plate and Steps

Bolting on the extension plate and steps, versus the current practice of welding, has two crucial advantages: it overcomes corrosion issues - induced by welding and repainting and it simplifies installation.



Aluminum Platform MAX GRIP® STANDARD

Lightweight aluminum platform design with recessed hinges provides a flat loading surface over entire width of platform. The platform features MAXGRIP® (knurled platform surface) and dual assist torsion springs that minimize the opening and closing force.



Max On-Lok®

By special order request (SOR) all GPTs can be ordered with the Max On-Lok® kit which makes them compatible with the most common vehicle dock restraint systems.



Fully Galvanized - STANDARD

Galvanization is the process by which zinc is coated over corrosive (easily rusted) metals. The process of galvanizing not only protects from corrosion of various 'soft metals' but also adds strength to the original, uncoated metal

M-181-1218



Maxon Lift Corp. 11921 Slauson Ave., Santa Fe Springs, CA 90670
800.227.4116 Fax 888.771.7713, www.maxonlift.com