

CONVENTIONAL SERIES **MAXON**[®]

GPC 17 X1 & 22 X1 Cantilevers



GPC 17 X1 & 22 X1 Specifications

The GPC X1 cantilever series combines the lowest weight in its class with exceptional durability and low maintenance requirements

- X1 technology simplifies the entire lifting mechanism by eliminating two cylinders. The simple structure means that there is less to maintain over the life of the liftgate
- Standard aluminum platform is robust and lightweight
- Standard dual cart stops and cab power cut off switch
- When stowed, the underside of the flat platform surface is ideal for decals
- Waterproof hand-held remote control
- Equipped with Service Switch, which enables the service mechanic to operate and test all lift functions
- Equipped with grease-free bearings

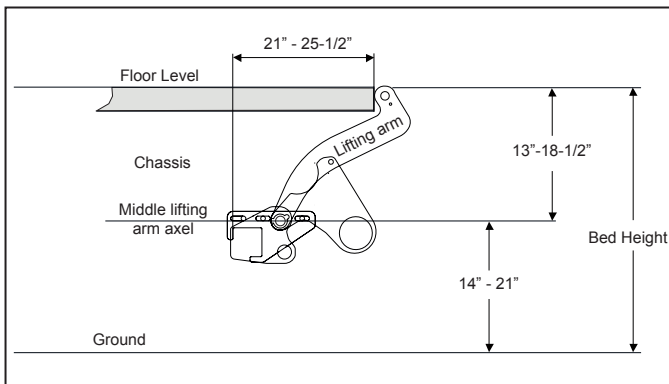

GPC 17 X1 Mounting Dimension

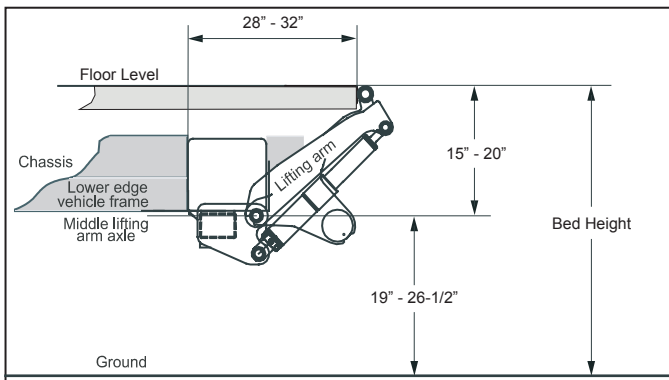

GPC 22 X1 Mounting Dimension

Please refer to installation manual for specific mounting requirements

MODEL CAPACITY	PLATFORM SIZE	STYLE	TOTAL WEIGHT	BED HEIGHT
GPC 17 X1 (1,700 Lbs.)	60" x 79"	Wedge	389 Lbs.	27.5" Min. Laden
	60" x 89"		399 Lbs.	39.5" Max. Unladen
GPC 22 X1 (2,200 Lbs.)	48" x 92"		558 Lbs.	40" Min. Laden
	48" x 98"		568 Lbs.	
	60" x 92"		580 Lbs.	51" Max. Unladen
	60" x 98"		590 Lbs.	
	72" x 92"		602 Lbs.	
	72" x 98"		612 Lbs.	

CONVENTIONAL SERIES **MAXON**[®]

GPC 17 X1 & 22 X1 Cantilevers

Standard Features

- Platform automatic leveling with soft landing
- Aluminum platform
- Platform warning lights
- Dual cart stops
- Platform ground rollers
- Stainless cylinder rods with nitrate treatment
- Completely sealed flat panel main control
- Hand held control
- Cab cut-off switch

Optional Features

- Full Door Seal Kit
- Flip-Up Door with Seal Kit
- Side Roll Off Guards
- Install Fixture
- 24 Volt Pump/Motor System

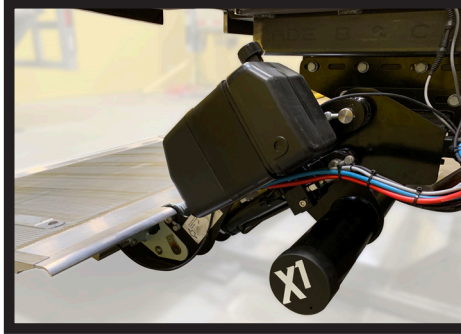

X1 Technology

X1 design technology allows a liftgate to raise and lower full lift capacity utilizing only one cylinder for up and down, and one for tilting. This is accomplished by the underrun bar which connects the lift and tilt arm mechanisms. This eliminates 20% of the total weight of a comparable four cylinder liftgate.



New Generation Control

The GPC main control is completely sealed and is only 3/16" thick. This design allows placement in many different locations

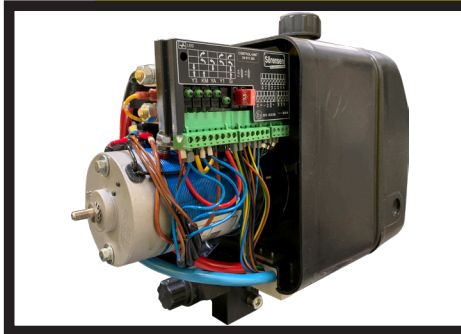

Control Unit with Built-In Diagnostics

LED lights allow for quick assessment and root cause tracing

Lift Switch On	Platform Position	Diagnose LED
No	Closed 90°	Off
Yes	Closed 90°	On
Yes	Open > 90°	Off
Yes	Horizontal 0°	Off
Yes	Tilted Down 0°-Minus 10°	On
Yes	Switch On Control Panel	Blink
Yes	Switch On Foot Control	Blink
Yes	Switch On Hand Control	Blink

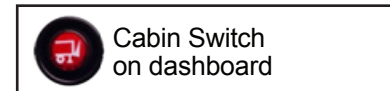

Distributed by:

M-263-0521